



## RECESSED DALI – TRACK

Our high-quality 3-circuit DALI track system is designed for the professional lighting market and is highly compatible with track lights that use 3-circuit DALI adapters from most major brands.

The track can be easily shortened and is immediately ready to install without the need to adjust wires. The easy-click mounting features make the track quick and simple to install.

A comprehensive range of DALI accessories are available, providing maximum freedom to create unique track systems. The twisted L and T connectors enable a quick and easy installation with fewer components. The same accessories can be used for both surface-mounted and recessed 3-circuit tracks.

### FEATURES

- 3-circuit DALI track
- Recessed mounted
- Standard lengths
- Black, white or grey finish
- Dedicated connectors
- Quick and easy installation
- IP20 ingress protection
- 5 year warranty

## SPECIFICATION

Track	Recessed DALI
Controls	DALI
Finish	White RAL9010   Black RAL9011   Grey RAL7040
Dimensions	W 56 mm x H 35.5 mm
Standard Lengths	1000 mm   2000 mm   3000 mm
Operating Voltage	230V/16A
Material	Aluminium/copper
Installation	Recced mounted
Ingress Protection	IP20
Weight	1.1 kg per meter
Operating Temperature	-25°C~50°C
Conformity	UKCA, RoHS
Warranty	5 Years

## DIMENSIONS

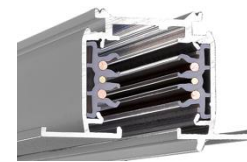
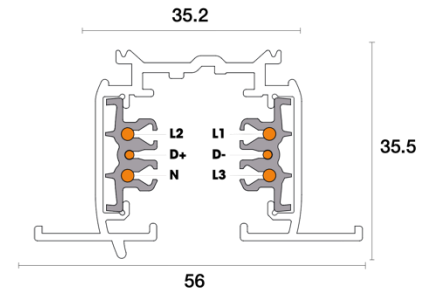

## CONNECTING DIAGRAM

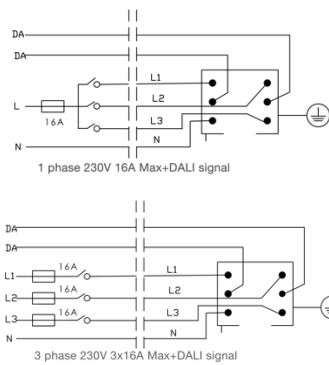

## MECHANICAL LOAD DIAGRAM

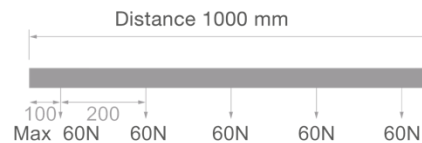

## FINISH OPTIONS

### COLOURS

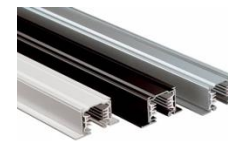

## PRODUCT ORDER CODE

EXAMPLE: DTR-B1000

PREFIX	FINISH	LENGTH
<b>DTR-</b>	<b>W</b> white RAL 9010	<b>1000</b> 1000 mm
	<b>B</b> black RAL 9011	<b>2000</b> 2000 mm
	<b>G</b> grey RAL 7040	<b>3000</b> 3000 mm

# DALI – 3 CIRCUIT TRACK SYSTEM - CONNECTORS

PRODUCT

DIMENSIONS/SPECIFICATION

PRODUCT CODE

## CONNECTOR LEFT DALI

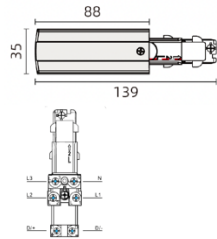

**Main materials**  
**Net weight per piece**  
**Inner box / outer box**  
**Rated voltage per circuit**

PC UL94V0 + Copper + Steel  
 61 grams  
 10 / 120 pcs  
 230V / 16A

**COLOURS**

**OPTIONS**  
 Dimmable

Black RAL 9011  
 White RAL 9010  
 Grey RAL 7040

**DT-CL-B**  
**DT-CL-W**  
**DT-CL-G**

## CONNECTOR RIGHT DALI

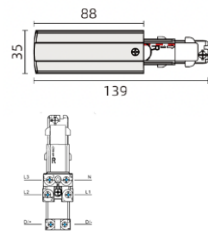

**Main materials**  
**Net weight per piece**  
**Inner box / outer box**  
**Rated voltage per circuit**

PC UL94V0 + Copper + Steel  
 61 grams  
 10 / 120 pcs  
 230V / 16A

**COLOURS**

**OPTIONS**  
 Dimmable

Black RAL 9011  
 White RAL 9010  
 Grey RAL 7040

**DT-CR-B**  
**DT-CR-W**  
**DT-CR-G**

## COUPLER DALI

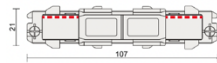

**Main materials**  
**Net weight per piece**  
**Inner box / outer box**  
**Rated voltage per circuit**

PC UL94V0 + Copper + Steel  
 40 grams  
 10 / 120 pcs  
 230V / 16A

**COLOURS**

**OPTIONS**  
 Dimmable

Black RAL 9011  
 White RAL 9010  
 Grey RAL 7040

**DT-CP-B**  
**DT-CP-W**  
**DT-CP-G**

## COUPLER (INSULATION)

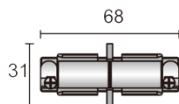

**Main materials**  
**Net weight per piece**  
**Inner box / outer box**  
**Rated voltage per circuit**

PC UL94V0 + Steel  
 22 grams  
 8 / 160 pcs  
 N/A

**COLOURS**

**OPTIONS**  
 Dimmable

Black RAL 9011  
 White RAL 9010  
 Grey RAL 7040

**ST-CPI-B**  
**ST-CPI-W**  
**ST-CPI-G**

## END CAP

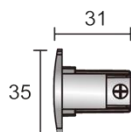

**Main materials**  
**Net weight per piece**  
**Inner box / outer box**  
**Rated voltage per circuit**

PC UL94V0 + Steel  
 9 grams  
 15 / 300 pcs  
 N/A

**COLOURS**

Black RAL 9011  
 White RAL 9010  
 Grey RAL 7040

**ST-EC-B**  
**ST-EC-W**  
**ST-EC-G**

# DALI – 3 CIRCUIT TRACK SYSTEM - CONNECTORS

PRODUCT

DIMENSIONS/SPECIFICATION

PRODUCT CODE

## MIDDLE DALI CONNECTOR

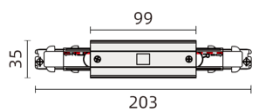

**Main materials**

Net weight per piece  
Inner box / outer box  
Rated voltage per circuit



PC UL94V0 + Copper + Steel  
129 grams  
10 / 120 pcs  
230V / 16A

**COLOURS**



**OPTIONS**

Dimmable



Black RAL 9011

**DT-MC-B**

White RAL 9010

**DT-MC-W**

Grey RAL 7040

**DT-MC-G**

## L CONNECTOR DALI LEFT

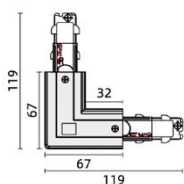

**Main materials**

Net weight per piece  
Inner box / outer box  
Rated voltage per circuit



PC UL94V0 + Copper + Steel  
125 grams  
12 / 60 pcs  
230V / 16A

**COLOURS**



**OPTIONS**

Dimmable



Black RAL 9011

**DT-LCL-B**

White RAL 9010

**DT-LCL-W**

Grey RAL 7040

**DT-LCL-G**

## L CONNECTOR DALI RIGHT

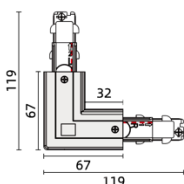

**Main materials**

Net weight per piece  
Inner box / outer box  
Rated voltage per circuit



PC UL94V0 + Copper + Steel  
125 grams  
12 / 60 pcs  
230V / 16A

**COLOURS**



**OPTIONS**

Dimmable



Black RAL 9011

**DT-LCR-B**

White RAL 9010

**DT-LCR-W**

Grey RAL 7040

**DT-LCR-G**

## T CONNECTOR DALI LEFT 1

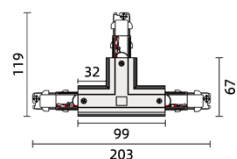

**Main materials**

Net weight per piece  
Inner box / outer box  
Rated voltage per circuit



PC UL94V0 + Copper + Steel  
132 grams  
9 / 54 pcs  
230V / 16A

**COLOURS**



**OPTIONS**

Dimmable



Black RAL 9011

**DT-TPL1-B**

White RAL 9010

**DT-TPL1-W**

Grey RAL 7040

**DT-TPL1-G**

## T CONNECTOR DALI LEFT 2

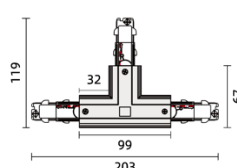

**Main materials**

Net weight per piece  
Inner box / outer box  
Rated voltage per circuit



PC UL94V0 + Copper + Steel  
192 grams  
9 / 54 pcs  
230V / 16A

**COLOURS**



**OPTIONS**

Dimmable



Black RAL 9011

**DT-TPL2-B**

White RAL 9010

**DT-TPL2-W**

Grey RAL 7040

**DT-TPL2-G**

# DALI – 3 CIRCUIT TRACK SYSTEM - CONNECTORS

PRODUCT

DIMENSIONS/SPECIFICATION

PRODUCT CODE

## T CONNECTOR DALI RIGHT 1

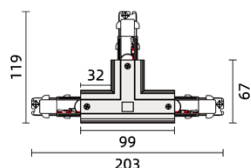

**Main materials**  
**Net weight per piece**  
**Inner box / outer box**  
**Rated voltage per circuit**



PC UL94V0 + Copper + Steel  
 192 grams  
 9 / 54 pcs  
 230V / 16A

**COLOURS**



Black RAL 9011

**DT-TCR1-B**

White RAL 9010

**DT-TCR1-W**

Grey RAL 7040

**DT-TCR1-G**

**OPTIONS**

Dimmable



## T CONNECTOR DALI RIGHT 2

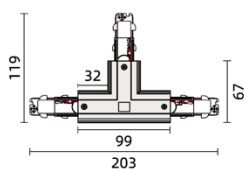

**Main materials**  
**Net weight per piece**  
**Inner box / outer box**  
**Rated voltage per circuit**



PC UL94V0 + Copper + Steel  
 192 grams  
 9 / 54 pcs  
 230V / 16A

**COLOURS**



Black RAL 9011

**DT-TCR2-B**

White RAL 9010

**DT-TCR2-W**

Grey RAL 7040

**DT-TCR2-G**

**OPTIONS**

Dimmable



## TWISTED L CONNECTOR

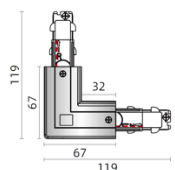

**Main materials**  
**Net weight per piece**  
**Inner box / outer box**  
**Rated voltage per circuit**



PC UL94V0 + Copper + Steel  
 125 grams  
 12 / 60 pcs  
 230V / 16A

**COLOURS**



Black RAL 9011

**DT-TLC-B**

White RAL 9010

**DT-TLC-W**

Grey RAL 7040

**DT-TLC-G**

**OPTIONS**

Dimmable



## TWISTED T CONNECTOR LEFT

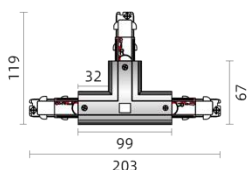

**Main materials**  
**Net weight per piece**  
**Inner box / outer box**  
**Rated voltage per circuit**



PC UL94V0 + Copper + Steel  
 192 grams  
 9 / 54 pcs  
 230V / 16A

**COLOURS**



Black RAL 9011

**DT-TTCL-B**

White RAL 9010

**DT-TTCL-W**

Grey RAL 7040

**DT-TTCL-G**

**OPTIONS**

Dimmable



## TWISTED T CONNECTOR RIGHT

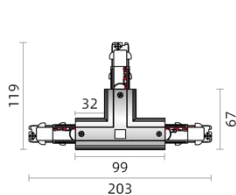

**Main materials**  
**Net weight per piece**  
**Inner box / outer box**  
**Rated voltage per circuit**



PC UL94V0 + Copper + Steel  
 192 grams  
 9 / 54 pcs  
 230V / 16A

**COLOURS**



Black RAL 9011

**DT-TTCR-B**

White RAL 9010

**DT-TTCR-W**

Grey RAL 7040

**DT-TTCR-G**

**OPTIONS**

Dimmable



# DALI – 3 CIRCUIT TRACK SYSTEM - CONNECTORS

PRODUCT

DIMENSIONS/SPECIFICATION

PRODUCT CODE

## FLEXIBLE DALI CONNECTOR

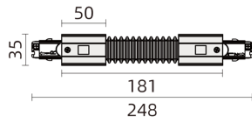

**Main materials**

Net weight per piece  
Inner box / outer box  
Rated voltage per circuit



PC UL94V0 + Copper + Steel  
177 grams  
12 / 60 pcs  
230V / 16A

**COLOURS**



**OPTIONS**

Dimmable



Black RAL 9011

**DT-FC-B**

White RAL 9010

**DT-FC-W**

Grey RAL 7040

**DT-FC-G**

## ADJUSTABLE DALI CONNECTOR

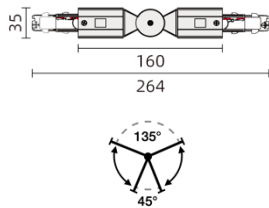

**Main materials**

Net weight per piece  
Inner box / outer box  
Rated voltage per circuit



PC UL94V0 + Copper + Steel  
145 grams  
15 / 90 pcs  
230V / 16A

**COLOURS**



**OPTIONS**

Dimmable



Black RAL 9011

**DT-AC-B**

White RAL 9010

**DT-AC-W**

Grey RAL 7040

**DT-AC-G**

## X DALI CONNECTOR

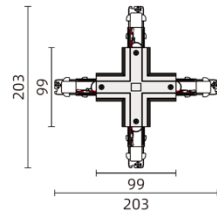

**Main materials**

Net weight per piece  
Inner box / outer box  
Rated voltage per circuit



PC UL94V0 + Copper + Steel  
265 grams  
2 / 24 pcs  
230V / 16A

**COLOURS**



**OPTIONS**

Dimmable



Black RAL 9011

**DT-XC-B**

White RAL 9010

**DT-XC-W**

Grey RAL 7040

**DT-XC-G**

## RECESSED END CAP

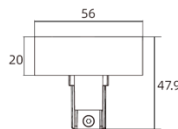

**Main materials**

Net weight per piece  
Inner box / outer box  
Rated voltage per circuit



PC UL94V0 + Copper + Steel  
11 grams  
24 / 288 pcs  
N/A

**COLOURS**



Black RAL 9011

**ST-REC-B**

White RAL 9010

**ST-REC-W**

Grey RAL 7040

**ST-REC-G**

## RECESSED DALI CONNECTOR COVER

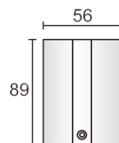

**Main materials**

Net weight per piece  
Inner box / outer box  
Rated voltage per circuit



PC UL94V0  
18 grams  
18 / 108 pcs  
N/A

**COLOURS**



Black RAL 9011

**DT-FC-B**

White RAL 9010

**DT-FC-W**

Grey RAL 7040

**DT-FC-G**

