



LIPOD – MICRO LINEAR

Our micro linear range delivers sophisticated low-profile luminaires, meticulously crafted to excel in discreet accent lighting applications. With a wealth of custom options, their versatile design seamlessly complements a wide array of interior settings, ensuring a tailored lighting solution for every space.

FEATURES

- 26.2 mm x 24.5 mm low-profile design
- Standard and custom lengths
- Direct lighting distribution
- 3000K, 4000K, tunable white, dim to warm and RGBW
- High lumen efficacy up to 130 lm/W
- CRI90+
- Low-glare polycarbonate diffuser
- Dedicated custom components
- A comprehensive range of mounting options
- Extruded aluminium channel
- Anodised or painted profile finish
- Compact driver
- DALI dimming and Casambi controls
- Plug-and-play wiring for quick installation
- IP20 as standard, IP65 on Request
- 7 year warranty



SPECIFICATION

Colour Temperature CCT	3000K 4000K TW D2W RGBW
Installation	Surface Suspended Recessed
Distribution	Direct
Diffuser	Opal Clear
Efficacy	Up to 130 lm/W
CRI	90 95
Controls	Fixed Output DALI Casambi
Finish	White Black Anodised
Dimensions	W 26.2 mm x H 24.5 mm
Standard Lengths	1000 mm 2005 mm 3010 mm Custom
Operating Voltage	24V
LED Light Source Power	4.8W - 24W
Material	Aluminium
LED Light Source	Max. W 8 mm x 2
Ingress Protection	IP20 IP65
Bending Possibility	Yes
Arc Radius	3000 mm
Lifetime	50,000hrs
Operating Temperature	-25°C ~45°C
Conformity	No UV or IR Emissions, UKCA
Warranty	7 Years
Notes	*Custom lengths available on request, LED light source and lumen efficiency may vary.

DIMENSIONS

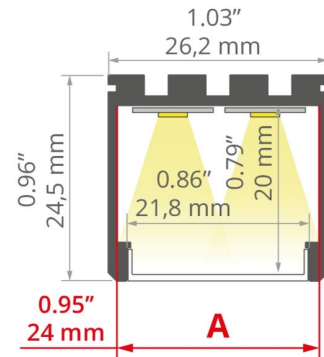

PHOTOMETRY

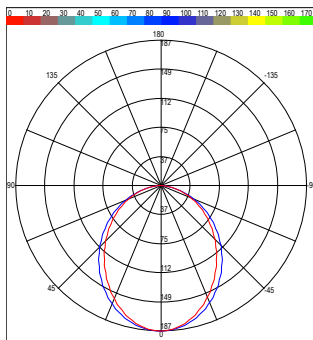

Opal Diffuser

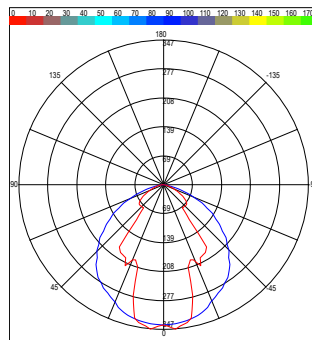















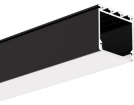
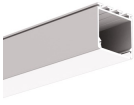
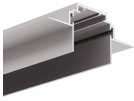







Clear Diffuser

PRODUCT ORDER CODE

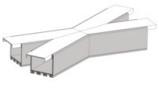
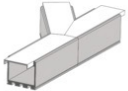
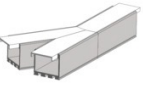
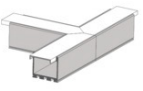
EXAMPLE: LIPOD-S4OAF2005

PREFIX	INSTALLATION	CCT	DIFFUSER	FINISH	DRIVER	LENGTH
LIPOD -	S surface	3 3000K	O frosted opal	A anodised aluminium	F fixed output	1000 1000 mm
	SP suspended	4 4000K	C clear	W white RAL 9016	D DALI	2005 2005 mm
	R recessed	TW tunable white	D drop-optic frosted opal	B black RAL 9005	C casambi	3010 3005 mm
		D2W dim2warm	D1 drop-optic frosted opal	RAL custom RAL colour		--- custom length*
		RGBW red/green/blue/white				

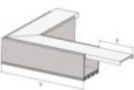
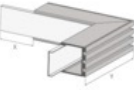
COMPONENTS

							
O opal diffuser	C clear	D opal - drop optic	DR opal - drop optic	W white finish RAL 9016 finish	B black finish RAL 9005 finish	A anodised finish	TEKUS recessed mounting track
							
EC closed end cap	MP-22 masking cover	GIP surface kit	REGIP-UV surface kit	RG-1 suspension kit	M1 wall kit	ZM-180 connector	ZM-NA-60 connector
							
ZM-NA-PION-120 connector	ZM-NA-90 connector	ZM-NA-PION-135 connector	X135 coupler	T135L coupler	T135R coupler	T90 coupler	L135 coupler
							
L135PW coupler	L135PZ coupler	L90 coupler	L90PW coupler	L90PZ coupler			

