

OREO – SUSPENDED PENDANT

OREO is a powerful and elegant circular luminaire. Its design features a circular die-cast aluminium form with a black or white finish that fits harmoniously into the surrounding architecture.

The glare-free microprismatic optic ensures optimal working light with high visual comfort - UGR19.

FEATURES

- Ø350 mm
- Efficacy up to 110 lm/W
- Direct and indirect light distribution
- Glare-free diffuser for consistent illumination
- UGR>19
- Suspended via rod or wire
- CRI80
- Compact driver
- DALI dimming options
- High quality aluminium body
- Black, white finish
- Plug-and-play wiring for quick installation
- IP40 as standard
- 5 year warranty

SPECIFICATION

Colour Temperature CCT	2700K 3000K 4000K
Power	14 W 18W (+ 10W with indirect)
Luminous Flux	Up to 2200 lm @4k 18W
Efficacy	Up to 110 lm/W
CRI	80
Controls	Fixed Output DALI
Diffuser	Microprismatic
UGR	>19
MacAdam Ellipse	3
Distribution	Direct Direct/Indirect
Beam Angle	90° direct / 110° indirect
Finish - Outside	Black RAL9005 White RAL 9016
Finish - Inside	Black White Gold
Dimensions	Ø350 mm x H 50 mm
Operating Voltage	34V 350mA 500mA
Material	Aluminium
Installation	Suspension Wire Suspension Rod
Ingress Protection	IP40
Lifetime	50,000hrs L80B10
Operating Temperature	-25°C ~35°C
Weight	4.1 kg (wire) 4.6 kg (rod)
Conformity	No UV or IR Emissions, UKCA
Warranty	5 Years

DIMENSIONS

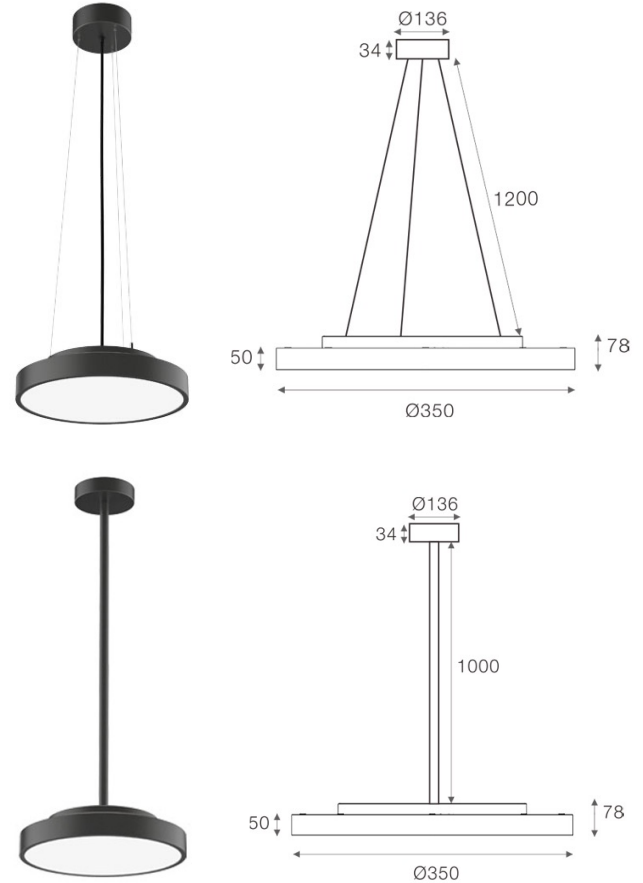

PHOTOMETRY

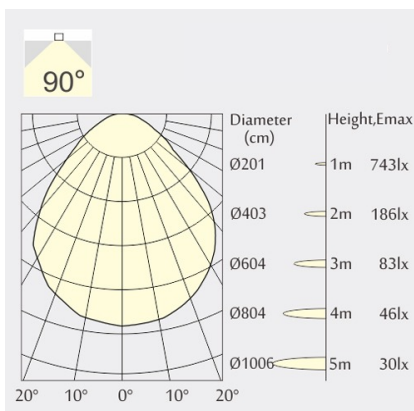

14W 2700K Ø350 mm

PRODUCT ORDER CODE

EXAMPLE: OREO350-SPD1427OWWF

PREFIX	INSTALLATION	DISTRIBUTION	POWER	CCT	OPTIC	FINISH/OUTSIDE	FINISH/INSIDE	DRIVERCONTROLS
OREPO350 -	SP suspended wire 1200mm	D direct	14 14W	27 2700K	O opal	W white	W white	F fixed output
	SP1 suspended rod 1000mm	DI direct/indirect	18 18W	3 3000K				
				4 4000K				
					B black	B black	D DALI	
							g gold	

